

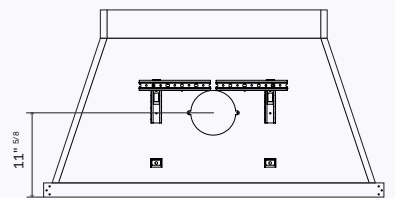

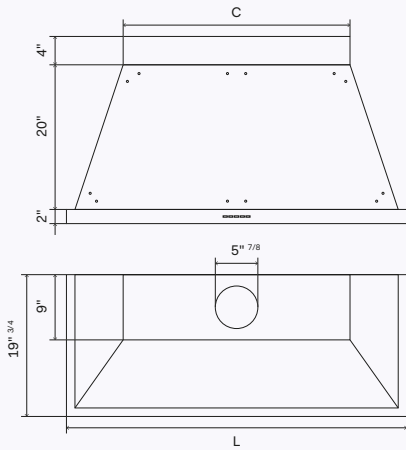







UANB

Wall-mounted extraction hood



Color range

Body

- | | | | | |
|--|---|---|---|---|
|  |  |  |  |  |
| White – WH | Antique white – AW | Stainless steel – SS | Graphite matt – MG | Glossy black – BK |
|  |  |  |  |  |
| Blue – MB | Burgundy red – BU | Emerald green – EG | Blue grey – BG | Optional RAL Classic – RA
+ \$ 1400.00 |

Finishes

Frames

- | | |
|---|---|
|  |  |
| Brass – G | Copper – P |
|  |  |
| Chrome – C | Burnished – B |



UANB30

L = 29" ⁷/₈ / C = 14" ¹/₈

Brass / Chrome / Burnished / Copper **\$ 5.249.00**

Stainless steel back panel (h. = 26" / sp. = ¹/₂")

AM4-76 **\$ 265.00**



UANB36

L = 35" ⁷/₈ / C = 19" ⁵/₈

Brass / Chrome / Burnished / Copper **\$ 5.424.00**

Stainless steel back panel (h. = 26" / sp. = ¹/₂")

AM4-90 **\$ 275.00**



UANB40

L = 39" ³/₈ / C = 23" ⁵/₈

Brass / Chrome / Burnished / Copper **\$ 5.559.00**

Stainless steel back panel (h. = 26" / sp. = ¹/₂")

AM4-100 **\$ 313.00**



UANB48

L = 47" ⁷/₈ / C = 31" ¹/₂

Brass / Chrome / Burnished / Copper **\$ 5.929.00**

Stainless steel back panel (h. = 26" / sp. = ¹/₂")

AM4-120 **\$ 349.00**



UANB60

L = 59" ¹/₂ / C = 43" ³/₄

Brass / Chrome / Burnished / Copper **\$ 7.293.00**

Stainless steel back panel (h. = 26" / sp. = ¹/₂")

AM4-150 **\$ 374.00**

General features

- Front LED bar
- Painted steel body, AISI 304 stainless steel (only inox version)
- Anodised aluminium filters
- Maximum air flow 600 cfm
- Automatic filter cleaning warning light
- Maximum power: 450 W
- 3 speeds + intensive
- Automatic delayed shutdown