



# TECHNICAL PORTAL USER GUIDE

# ILVE service portal user guide

Link to access the service portal

 [ilve.desys.it](https://ilve.desys.it)

Credentials communicated by ILVE

After the first login, you will be able to change it

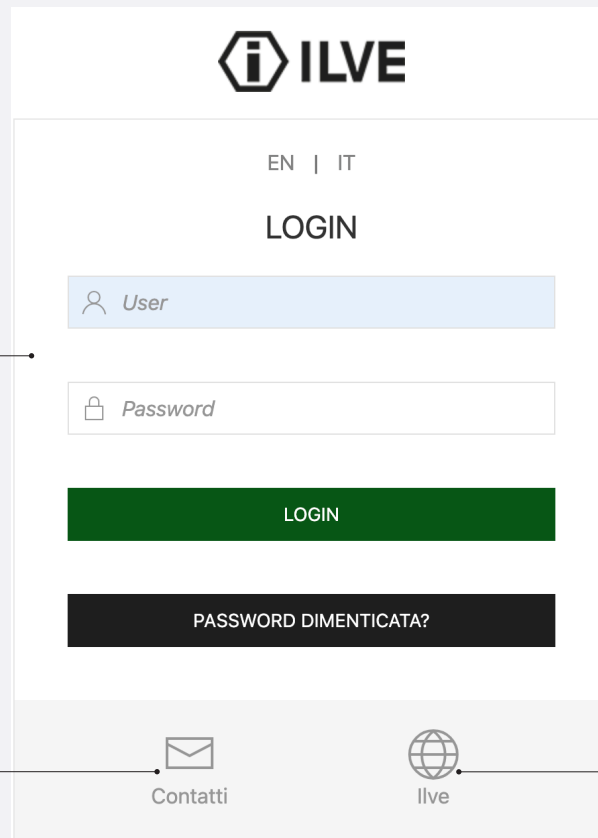

The screenshot shows the ILVE service portal login page. At the top is the ILVE logo. Below it are language options 'EN | IT'. The main heading is 'LOGIN'. There are two input fields: 'User' (with a person icon) and 'Password' (with a lock icon). Below the fields are two buttons: a green 'LOGIN' button and a black 'PASSWORD DIMENTICATA?' button. At the bottom of the page, there are two icons: an envelope icon labeled 'Contatti' and a globe icon labeled 'ilve'.

Form to contact ILVE



Link to ILVE website

# 00. Content

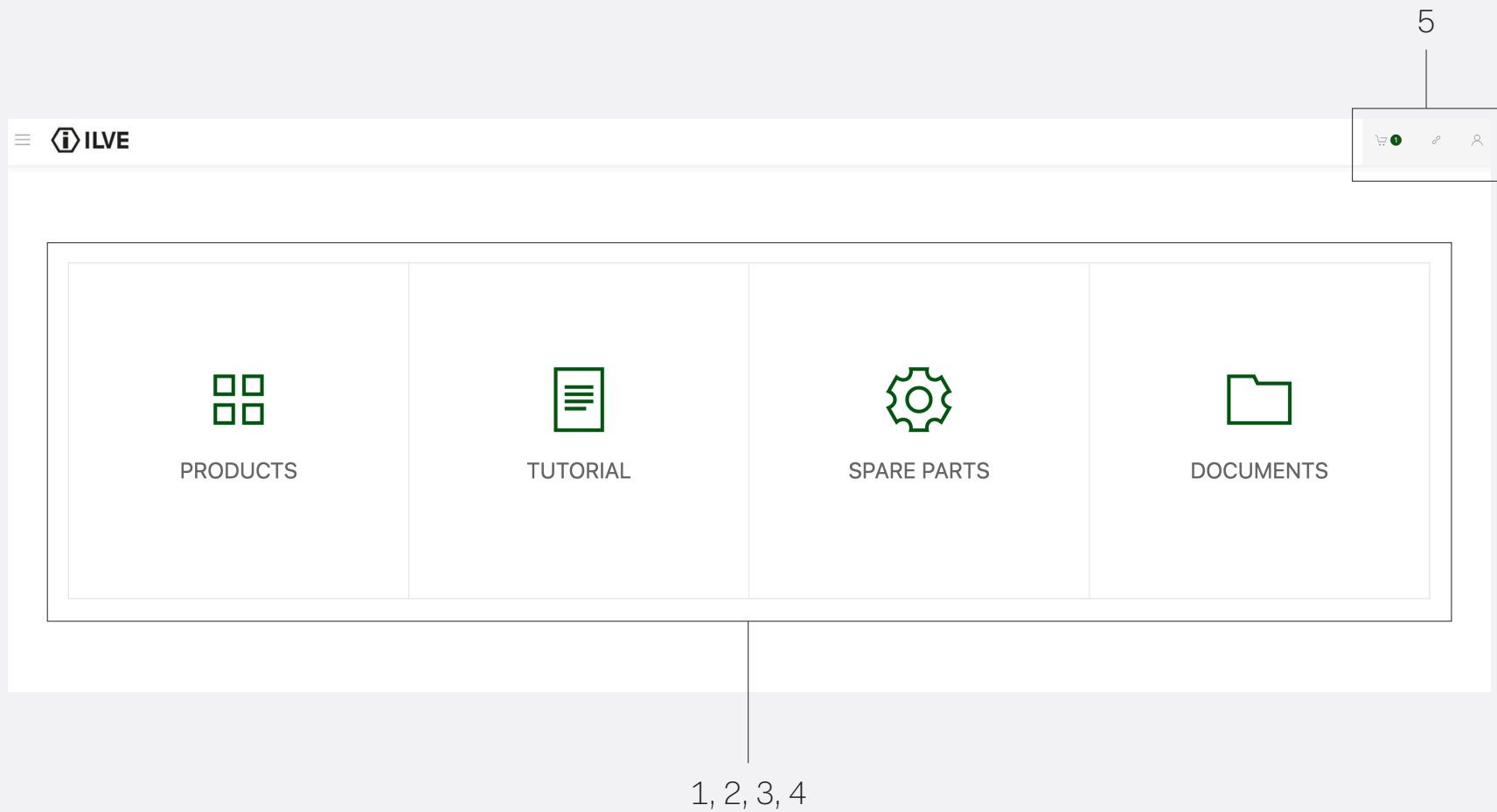

# Content 1. 2. 3. 4.

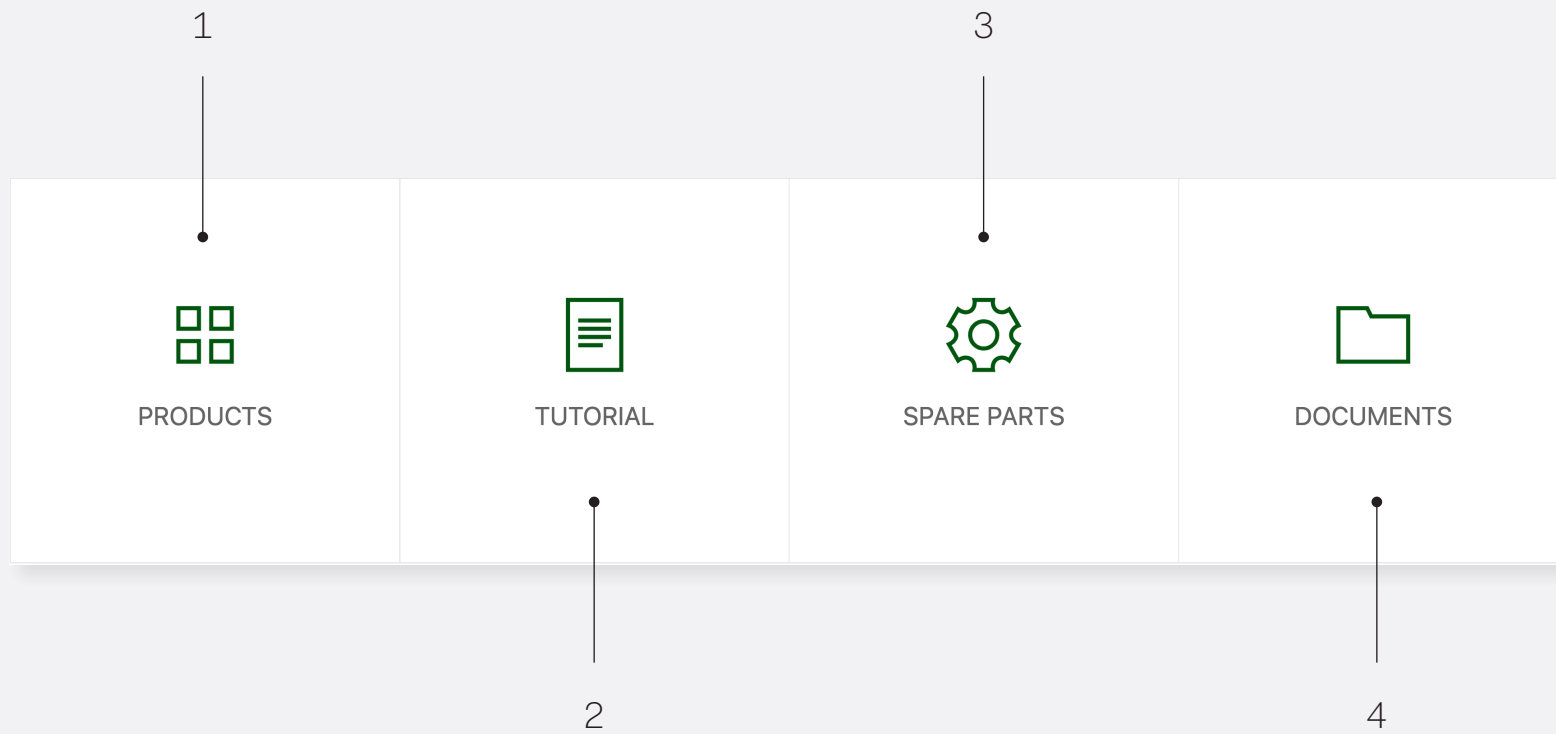

# 01. Products



PRODUCTS



TUTORIAL



SPARE PARTS



DOCUMENTS

# 01. Products



In this section, you will find the products along with the related documentation: illustrations, user and installation manuals, wiring diagrams, and error lists.

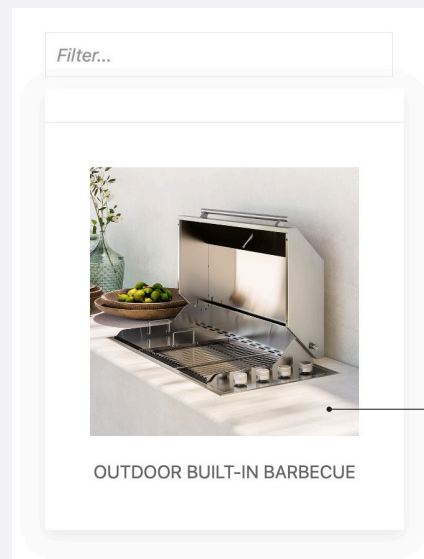

Click to enter

01.  
Products

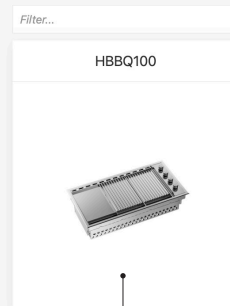

Click to enter

01.  
Products

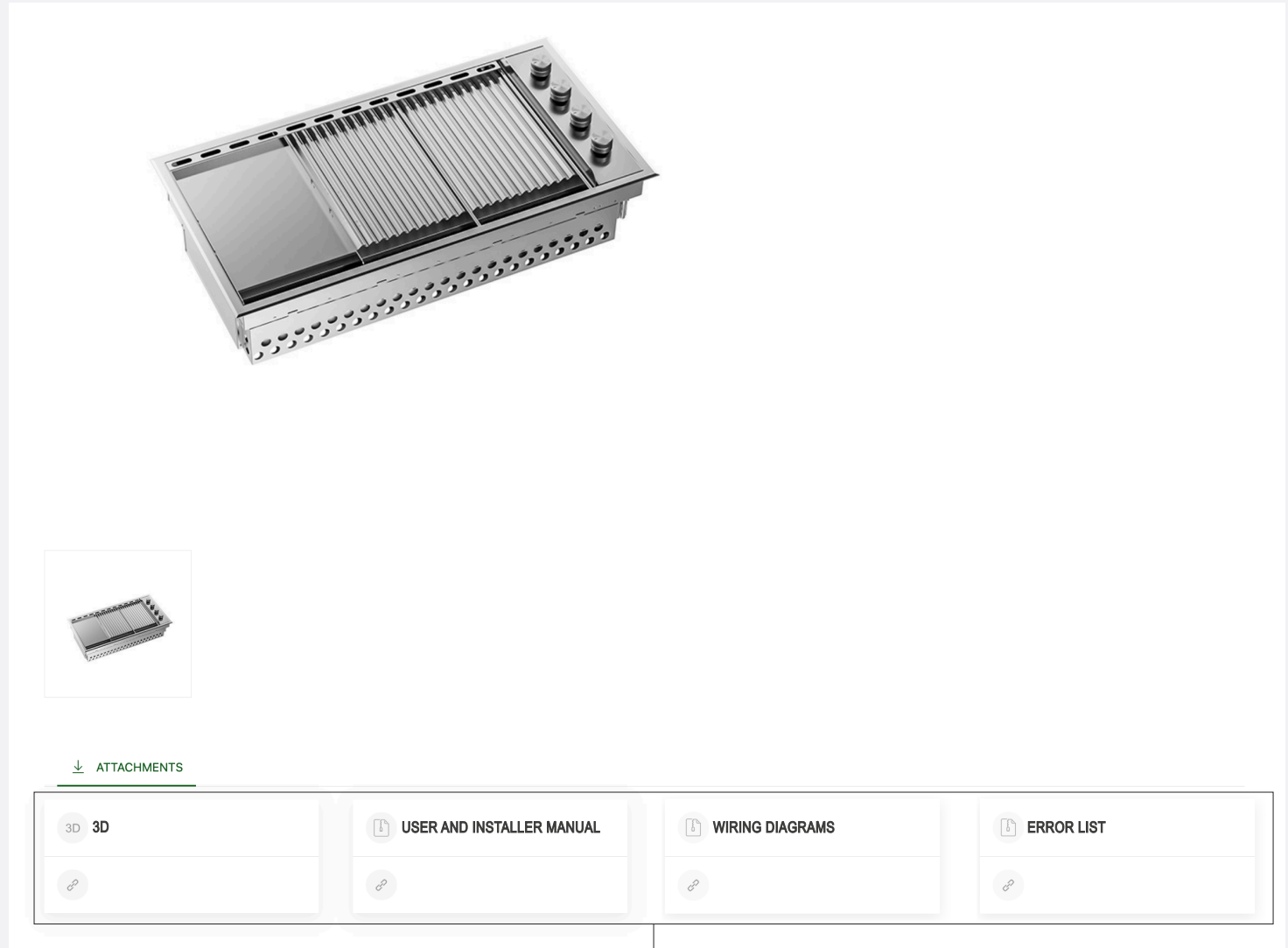

Here, you will find the available documentation.  
Please note: the 3D illustrations are for reference only and may not reflect the latest version of the product.

## 02. Tutorial

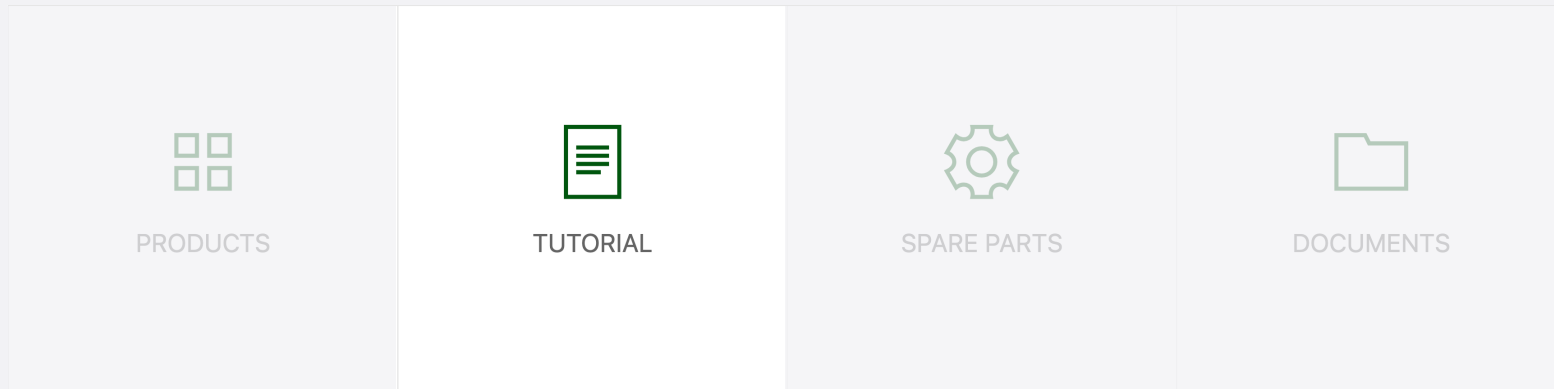

## 02. Tutorial

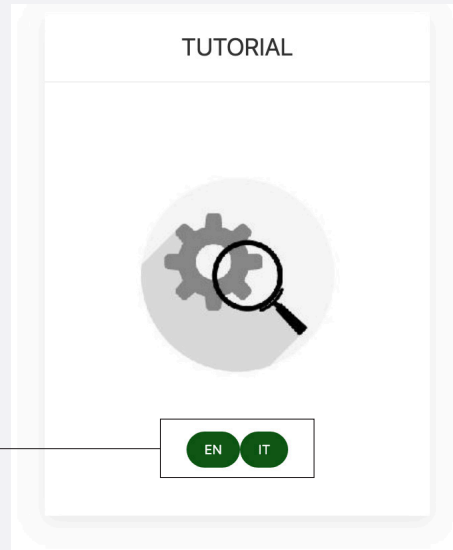

Languages

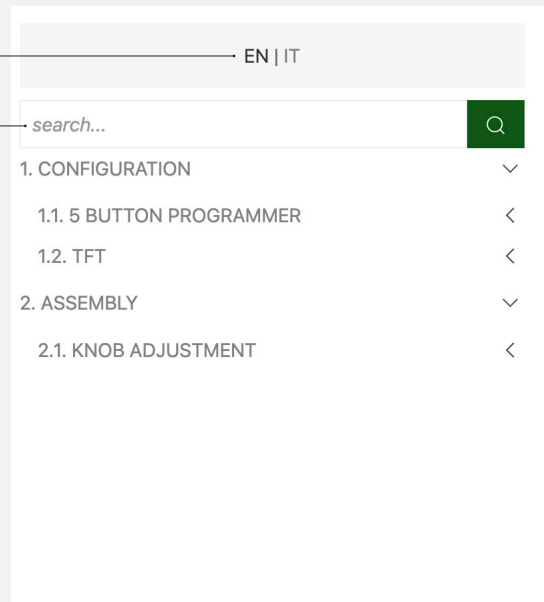

Languages

Search bar

**Attention:**  
The search bar allows you to search within chapters, not within the entire content

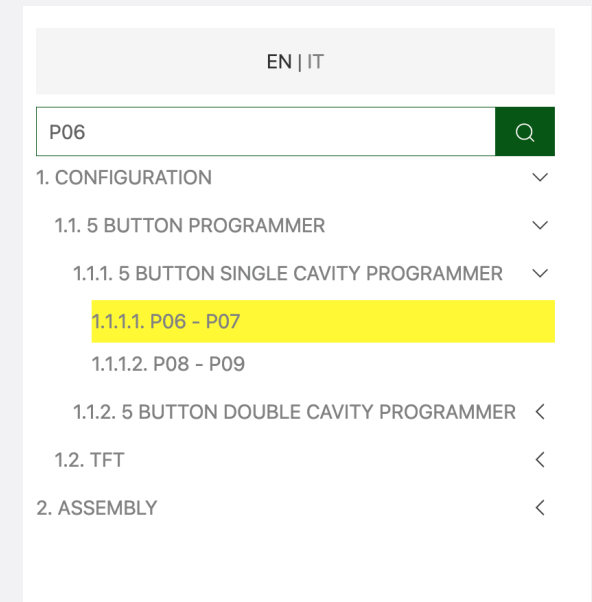

# 02. Tutorial

EN | IT

p06

- 1. CONFIGURATION
  - 1.1. 5 BUTTON PROGRAMMER
    - 1.1.1. 5 BUTTON SINGLE CAVITY PROGRAMMER
      - 1.1.1.1. P06 - P07**
      - 1.1.1.2. P08 - P09
    - 1.1.2. 5 BUTTON DOUBLE CAVITY PROGRAMMER
  - 1.2. TFT
- 2. ASSEMBLY

## P06 - P07

5 BUTTON MONO 60 PROGRAMMER ITALY

ILVE

P06 P07 | 5 BUTTON PROGRAMMER MONO 60 IT  
P06 P07 | PROGRAMMATORE 5 TASTI MONO 60 IT

0:00 / 0:38

Full screen view

## 5 BUTTON MONO 80 PROGRAMMER ITALY

ILVE

P08 P09 | 5 BUTTON PROGRAMMER MONO 80 EU  
P08 P09 | PROGRAMMATORE 5 TASTI MONO 80 EU

0:00 / 0:33



## 03. Spare parts



PRODUCTS



TUTORIAL



SPARE PARTS



DOCUMENTS

### 03.

## Spare parts

#### Type of search:

- A. Search by model
- B. Search by serial number
- C. Search by spare parts

A. Search by model is intended for generic finished products. We strongly recommend not using it, as it is not updated with current production details and does not display color variations

B. Search by serial number is the most accurate method, as it reflects the current configuration of the product, including color variations

C. Search by component code is useful for stock orders when the component code is already known

#### Search by model

Catalogue \*

SEARCH

#### Search by Serial Number

Serial number (min. 4 chars) \*

SEARCH

#### Search by spare parts

Code \*

SEARCH



03.A-03.B.

Search by model

and

Search by serial

number

Display mode

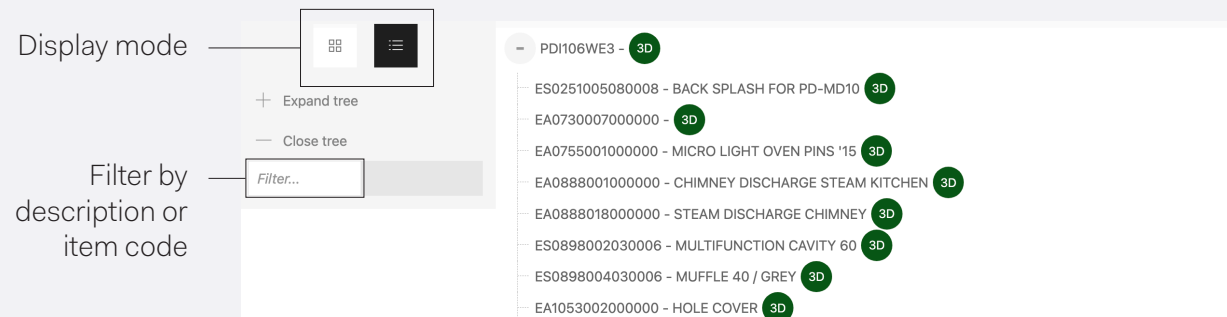
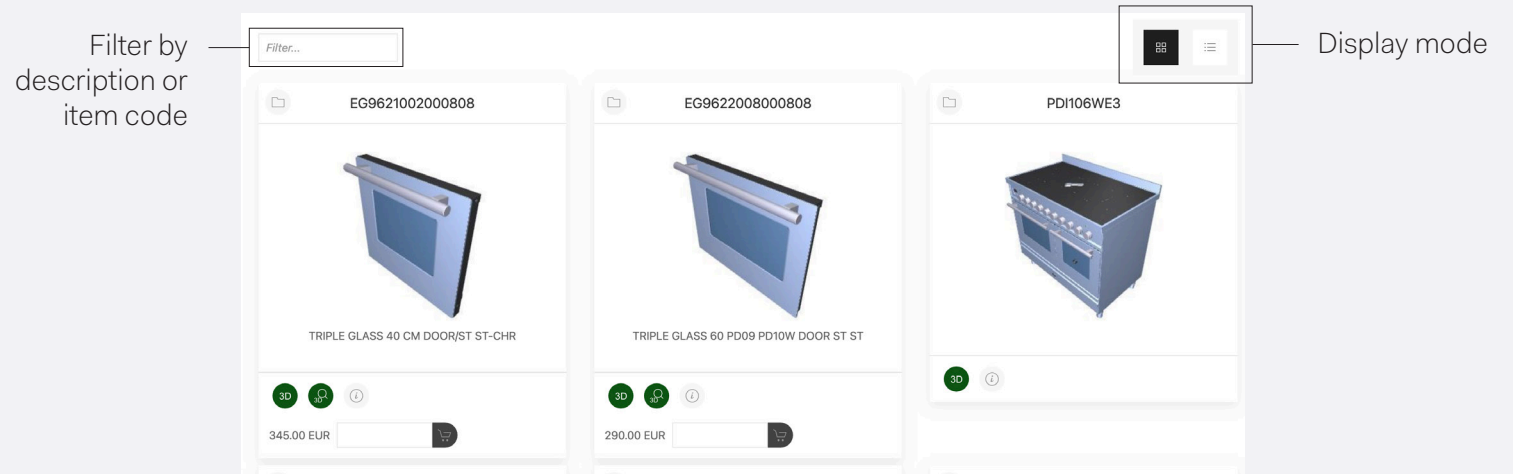

03.A-03.B.

Search by model

and

Search by serial

number

Display mode



The image shows a product page for a 'TRIPLE GLASS 60 PD09 PD10W DOOR ST ST' with model number EG9622008000808. The price is 290.00 EUR. Annotations point to various UI elements: 'Open parent in 3D' points to the product title; 'Open 3D' points to the 3D view icons; 'Choose quantity' points to the quantity selector; 'Add to cart' points to the cart icon; and 'Details' points to the details modal.

EG9622008000808

TRIPLE GLASS 60 PD09 PD10W DOOR ST ST

290.00 EUR

Open parent in 3D

Open 3D

Choose quantity

Add to cart

Details

EG9622008000808

Description: **TRIPLE GLASS 60 PD09 PD10W DOOR ST ST**

290.00 EUR

3D Spares and Maintenance

DESCRIPTION	VIEW
9622008_0.vds	3D

### 03.A-03.B.

Search by model  
and  
Search by serial  
number

Display mode



Expand or close tree

Open 3D

Open parent in 3D

Choose quantity and add to cart

ES0251005080008  
Description: **BACK SPLASH FOR PD-MD10**

27.50 EUR

3D Spares and Maintenance

DESCRIPTION	VIEW
0251005_0.vds	3D

- PD1106WE3 - 3D
- ES0251005080008 - BACK SPLASH FOR PD-MD10 3D
- EA0730007000000 - 3D
- EA0755001000000 - MICRO LIGHT OVEN PINS '15 3D
- EA0888001000000 - CHIMNEY DISCHARGE STEAM KITCHEN 3D
- EA0888018000000 - STEAM DISCHARGE CHIMNEY 3D
- ES0898002030006 - MULTIFUNCTION CAVITY 60 3D
- ES0898004030006 - MUFFLE 40 / GREY 3D
- EA1053002000000 - HOLE COVER 3D
- 1055004 3D
- ES1058021000000 - AIR CONVEYER 3D
- EA1059002000000 - NON-ALIGNED FASTON 3D
- EA1060001000000 - INDUCTION GENERATOR COVER 3D
- ES1067009010000 - TERMINAL BOARD COVER 3D
- ES1068043010000 - BACK COVER SX LD-PD10 3D
- ES1068087010000 - BACK COVER DX L-P 3D
- ES1070002030006 - FAN COVER 3D
- ES1076009080008 - CONTROL BOARD LD-PD106/ ST ST 3D
- EA1201007000000 - NUT 3D
- EA1290003000000 - SPACER 3D

### 03.A-03.B.

Search by model  
and  
Search by serial  
number

#### Display mode



Select and  
rotate

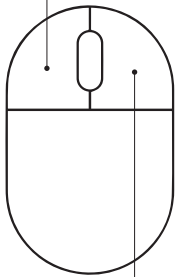

Drag



Displays the  
component and its  
subcomponents in  
the assembly you  
have chosen to  
view

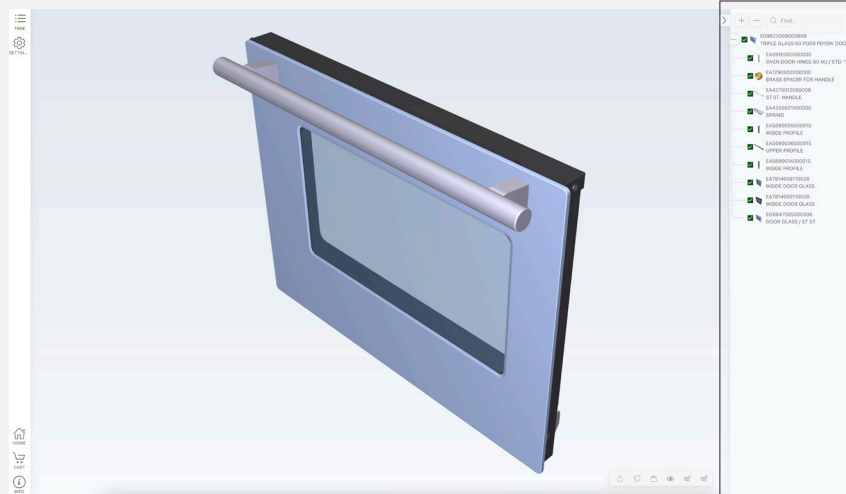

Displays the  
component and its  
subcomponents  
within the parent  
assembly



Find...

- PD106WE3
  - ES0251005080008 BACK SPLASH FOR PD-MD10
  - EA0730007000000
  - EA0755001000000 MICRO LIGHT OVEN PINS '15
  - EA0888001000000 CHIMNEY DISCHARGE STEAM KIT
  - EA0888018000000 STEAM DISCHARGE CHIMNEY
  - ES0898002030006 MULTIFUNCTION CAVITY 60
  - ES0898004030006 MUFFLE 40 / GREY
  - EA1053002000000 HOLE COVER
  - 1055004
  - ES1058021000000 AIR CONVEYER
  - EA1059002000000 NON-ALIGNED FASTON
  - EA1060010000000 INDUCTION GENERATOR COVER

**ES0251005080008**

27.50 EUR 1

CODE: ES0251005080008

DESCRIPTION: BACK SPLASH FOR PD-MD10

Choose quantity  
and add to cart

# 03.A-03.B.

Search by model  
and  
Search by serial  
number



## Display mode

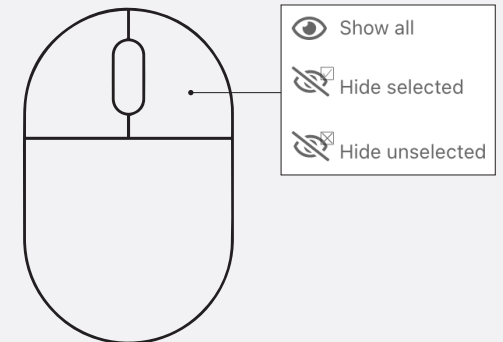
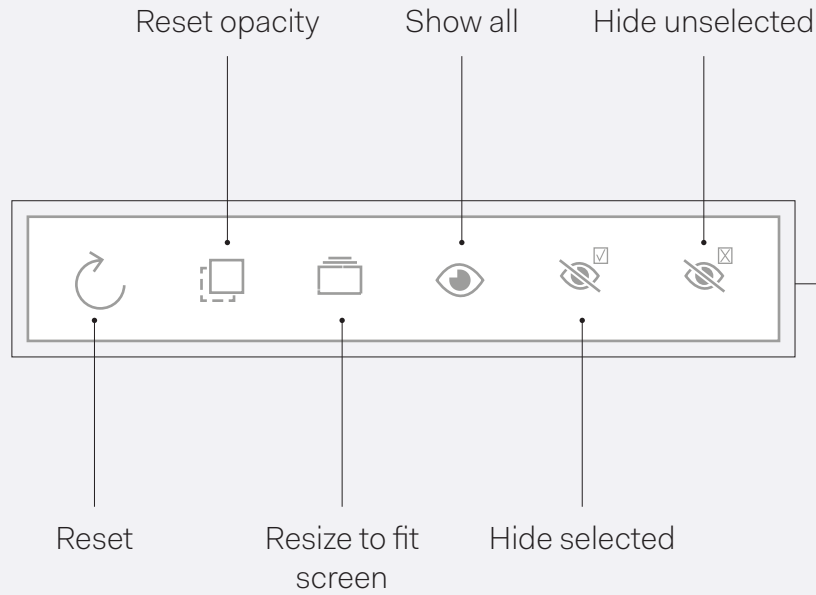
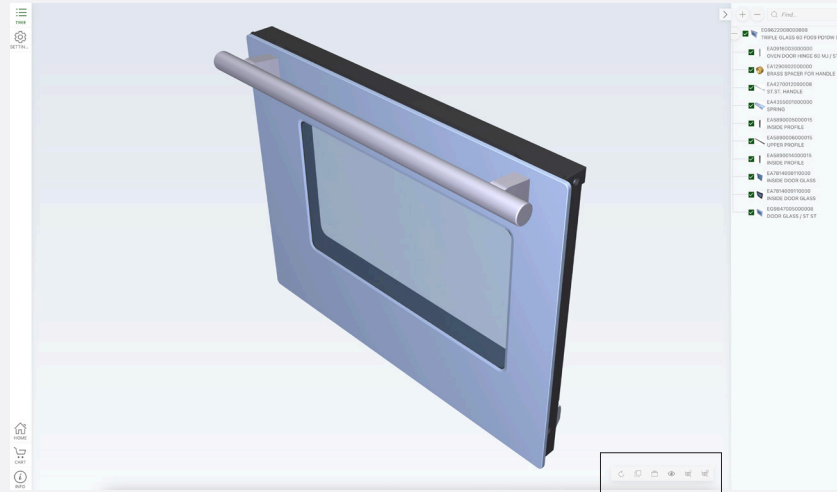

## 03.C

### Search by spare parts

#### Search by spare parts

Code \*

 *Insert the code, at least 5 characters*

**SEARCH**

Insert the code (at least 5 characters)

#### Results

CODE	REVISION	DESCRIPTION	PRICE (EUR)	QUANTITY
KBR002	0	COMPLETE FISH BURNER (2 HOLES)	48.00	<input type="text"/> <b>ADD</b>

Choose quantity and add to cart



# 04. Documents

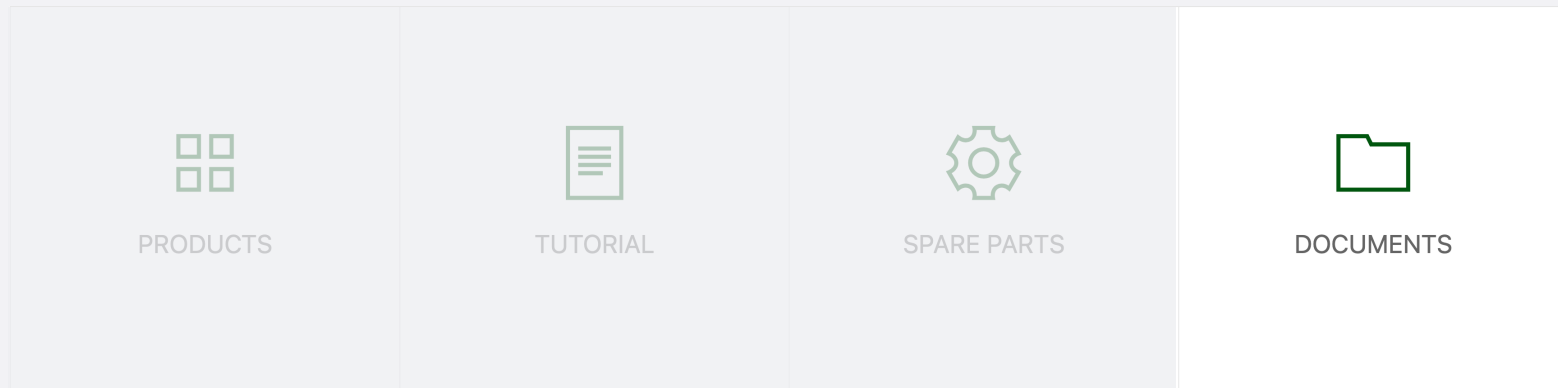

## 04. Documents

In this section you will find the documentation of the products (spare parts exploded view of the discontinued products, use and installation manual, electrical diagrams, error list...)

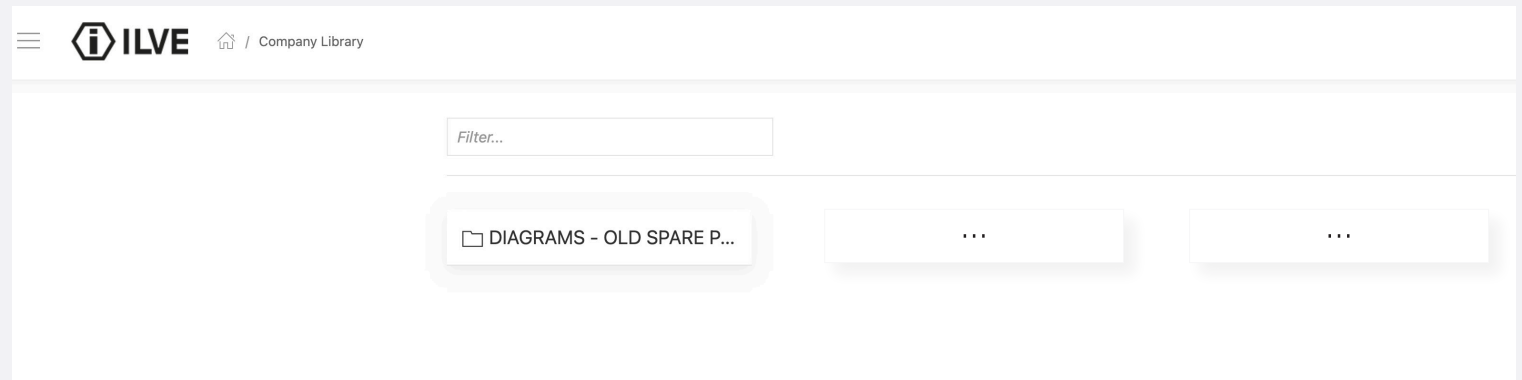

05.

Go to cart and  
personal area

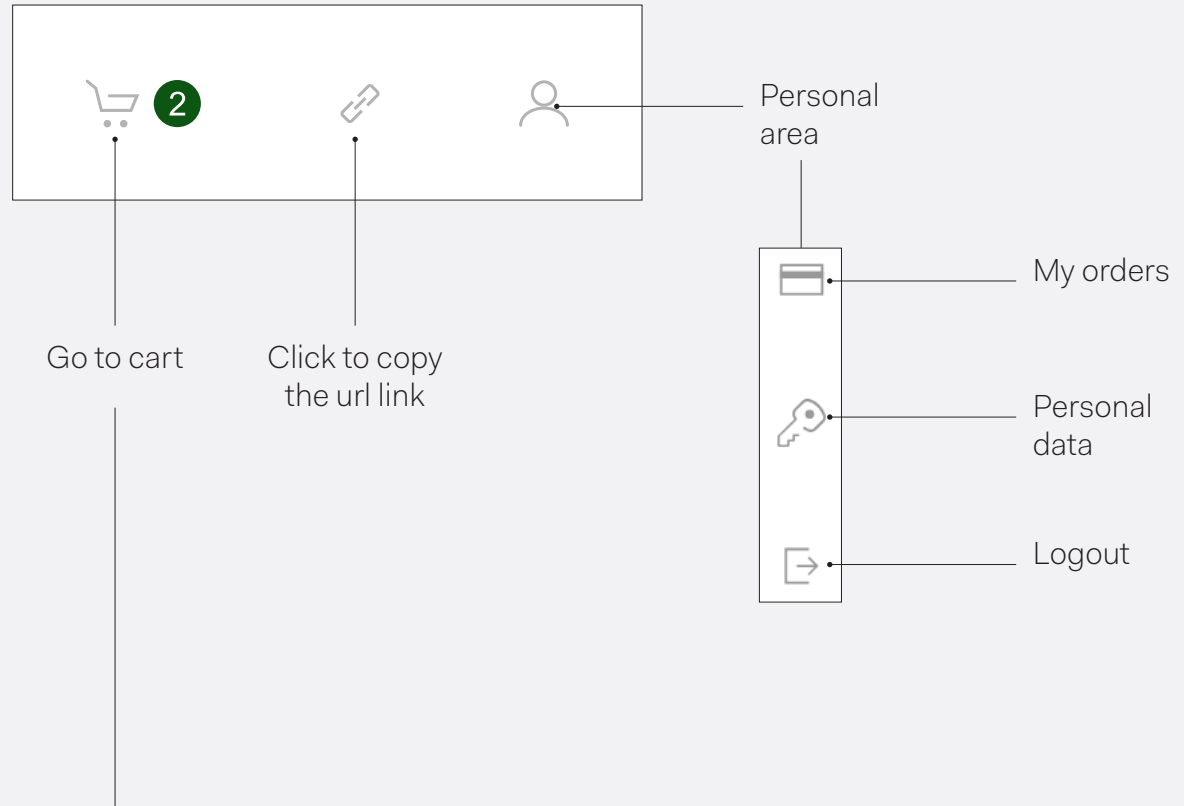

CART SUMMARY    ADDRESSES    CHECKOUT

## Cart summary

PREVIEW	SERIAL NUMBER	CODE	DESCRIPTION	PRICE	QUANTITY	DELETE
		KBR002	COMPLETE FISH BURNER (2 HOLES)	48.00 EUR (48.00)	1    EDIT	⊗
	24020209	EG9621002000808	TRIPLE GLASS 40 CM DOOR/ST ST-CHR	345.00 EUR (345.00)	1    EDIT	⊗
				393.00 EUR		

**NEXT**



05.

Go to cart and  
personal area



Remember to enter your  
personal data before  
placing your order

1 2 3 4

PERSONAL DATA E-MAIL CHANGE PASSWORD ADDRESSES

**PERSONAL DATA**

First name \*

Last name \*

Company \*

Phone

Address

Country

Province

City

Zip code

Vat Code

SAVE

The form is a user profile management interface. It features a dark navigation bar with four tabs: 'PERSONAL DATA', 'E-MAIL', 'CHANGE PASSWORD', and 'ADDRESSES'. The 'PERSONAL DATA' tab is active and highlighted. Above the tabs, numbers 1, 2, 3, and 4 are positioned, with vertical lines pointing to the 'PERSONAL DATA', 'E-MAIL', 'CHANGE PASSWORD', and 'ADDRESSES' tabs respectively. The 'PERSONAL DATA' section contains several input fields: 'First name \*', 'Last name \*', and 'Company \*' (all with person icons); 'Phone' (with a phone icon); 'Address' (with a location pin icon); 'Country' (a dropdown menu with a location pin icon); 'Province' (with a location pin icon); 'City' (with a location pin icon); 'Zip code' (with a location pin icon); and 'Vat Code' (with a location pin icon). A green 'SAVE' button is located at the bottom of the form.



05.

Go to cart and  
personal area

Cart summary

CART SUMMARY    ADDRESSES    CHECKOUT

### Cart summary

PREVIEW	SERIAL NUMBER	CODE	DESCRIPTION	PRICE	QUANTITY	DELETE
		KBR002	COMPLETE FISH BURNER (2 HOLES)	48.00 EUR (48.00)	1 <input type="button" value="EDIT"/>	<input type="button" value="X"/>
	24020209	EG9621002000808	TRIPLE GLASS 40 CM DOOR/ST ST-CHR	345.00 EUR (345.00)	1 <input type="button" value="EDIT"/>	<input type="button" value="X"/>
				393.00 EUR		

Possibility to  
change the quantity

Possibility to delete  
the item



05.

Go to cart and personal area

CART SUMMARY | ADDRESSES | CHECKOUT

ADD A NEW ADDRESS

No shipping address associated to your account

NEXT

If no address is specified, click here to enter your details

Address

ADD

First name \*  
Last name \*  
Company \*

Email \*  
Address \*  
Country \*

Province \*  
City \*  
Zip code

Phone \*

SAVE

Now you can select the address you just entered and continue with the pre-order

CART SUMMARY | ADDRESSES | CHECKOUT

ADD A NEW ADDRESS

VIA ANTONIANA 100 CAMPODARSEGO (35011) - PADOVA (IT)

Gaia Piazza, ILVE SPA - Phone: 0499200990 - Email: gaia.piazza@ilve.com

NEXT



05.

Go to cart and personal area

### Checkout

The screenshot shows a checkout page with the following sections:

- Shipping address:** VIA ANTONIANA 100 CAMPODARSEGO (35011) - PADOVA (IT), Gaia Piazza, ILVE SPA - Phone 0499200990 - Email gaia.piazza@ilve.com
- Billing information:** Gaia Piazza, ILVE () - Phone - Email gaia.piazza@ilve.com
- Checkout Table:**

PREVIEW	SERIAL NUMBER	CODE	DESCRIPTION	PRICE	QUANTITY
		KBR002	COMPLETE FISH BURNER (2 HOLES)	48.00 EUR (48.00)	1
	24020209	EG9621002000808	TRIPLE GLASS 40 CM DOOR/ST ST-CHR	345.00 EUR (345.00)	1
				<b>393.00 EUR</b>	
- Notes:** A text input field for adding notes.
- Files:** A file upload area with the text "Click here or Drag file from your Computer".
- SEND:** A green button to submit the pre-order.

Possibility to add text notes

Possibility to add attachments

Send pre-order

Once you have placed your pre-order, it will appear in the "My Orders" section of your personal area. ILVE will review and verify the order, and a confirmation email will be sent to you.

